

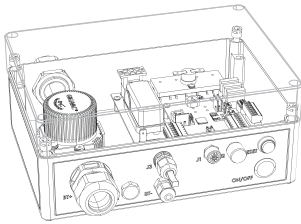

## QUICK START GUIDE

## BATTERY INTERFACE BOX (BIB)



1

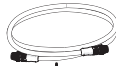

2



3

1

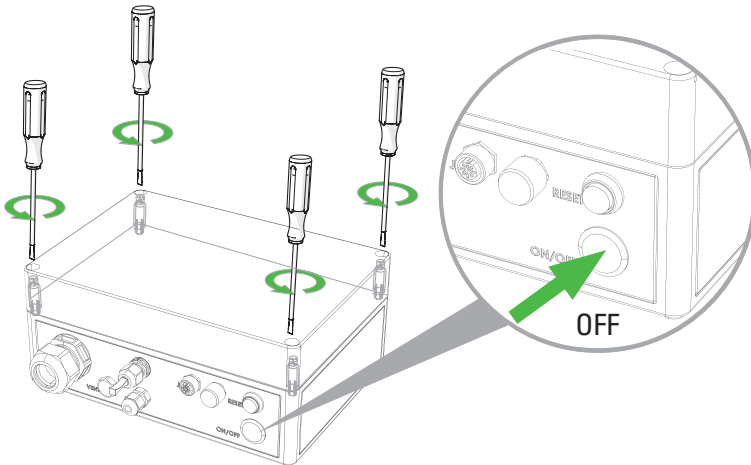

2

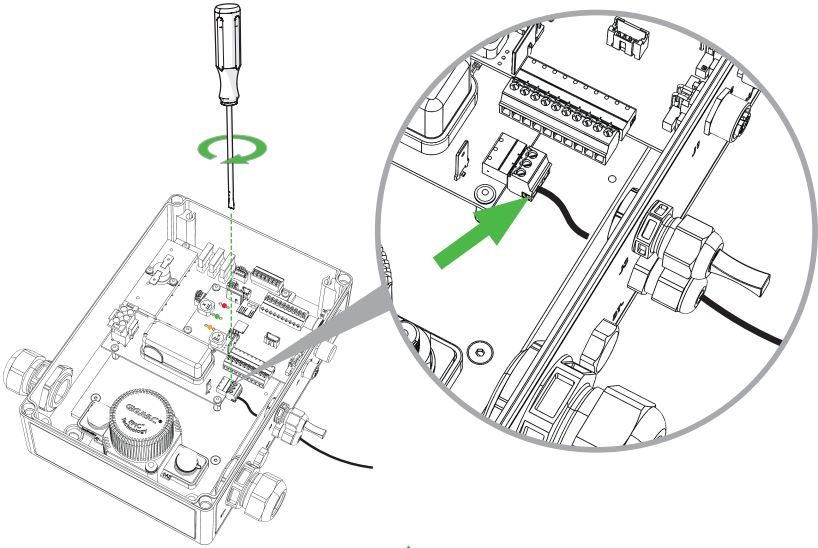

3

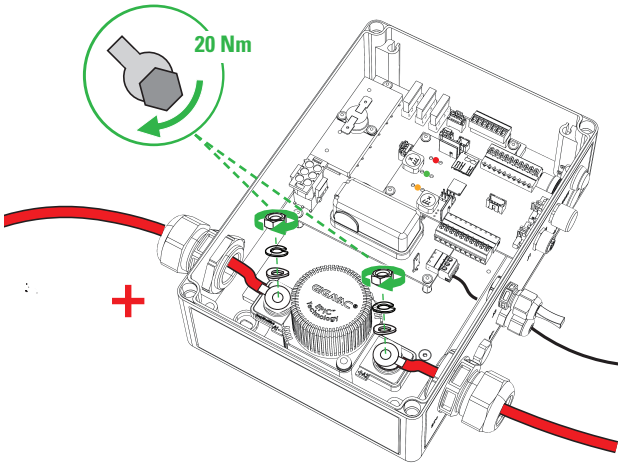

4

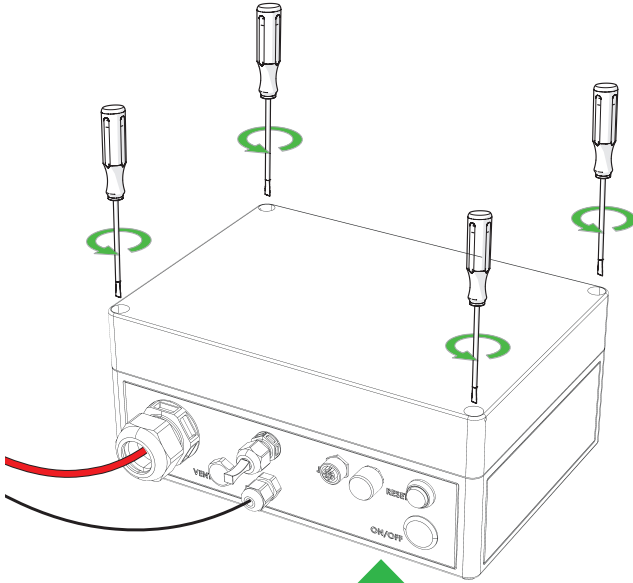

5

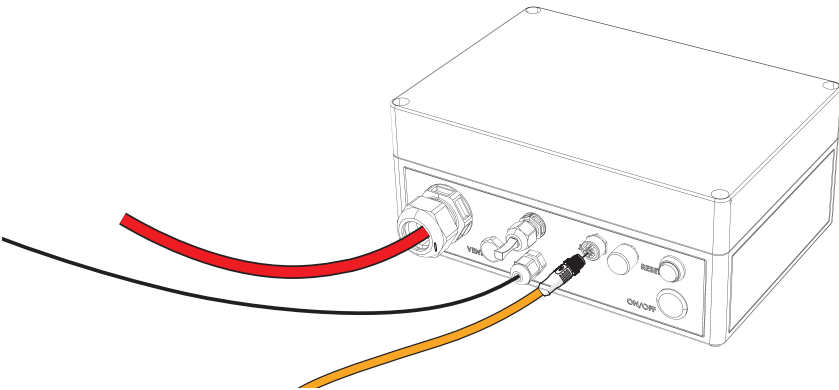

**6A**

## CONNECTING THE BIB TO A NOMIA BATTERY

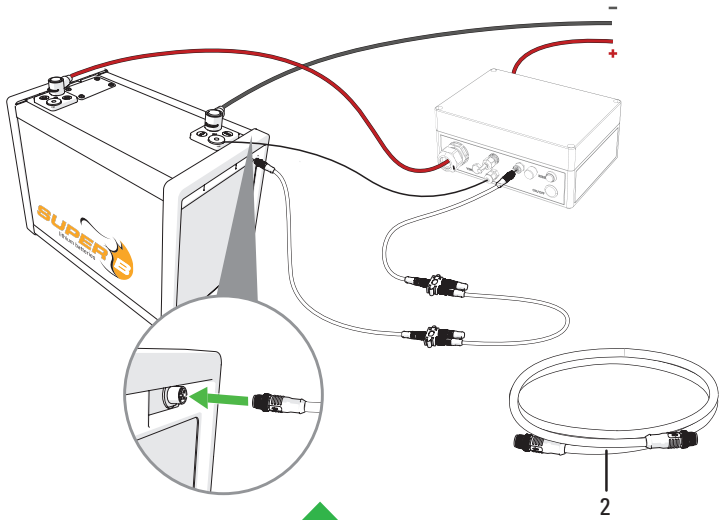

**6B**

## CONNECTING THE BIB TO A NOMADA BATTERY

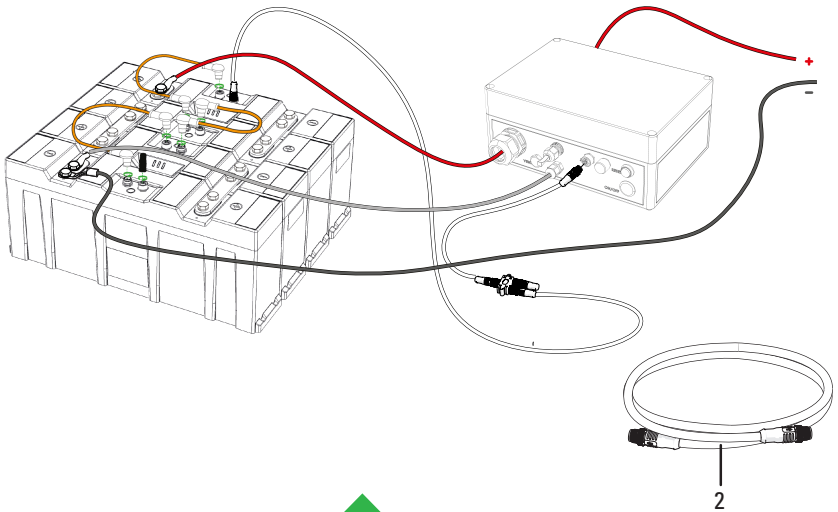

7

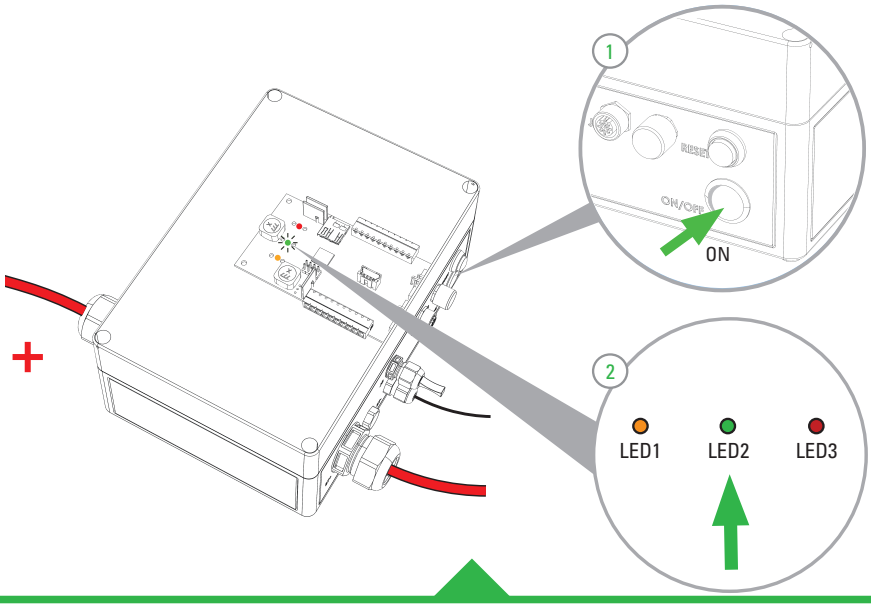

8

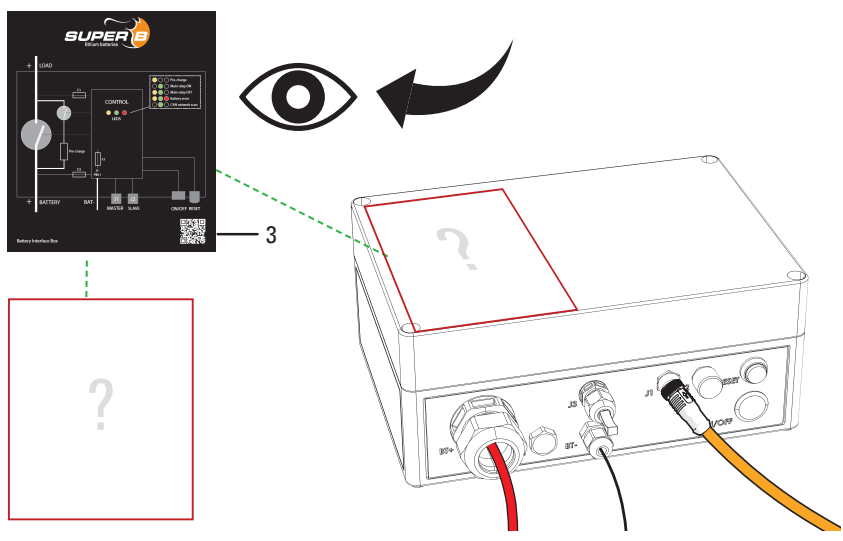

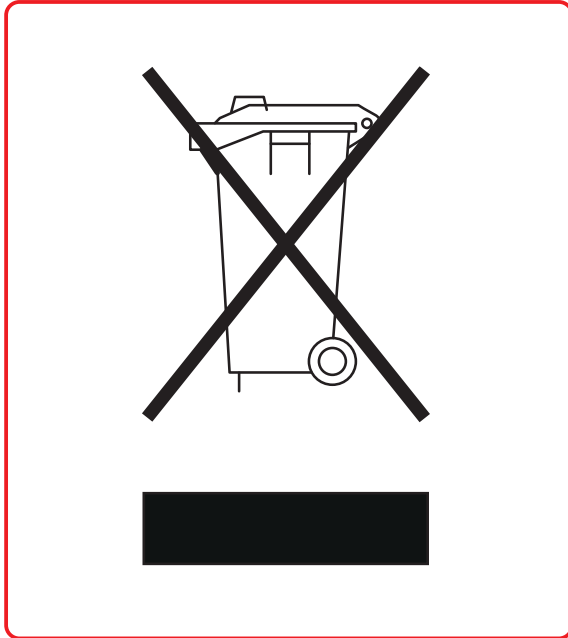

Download User Manual at:  
[www.super-b.com](http://www.super-b.com)

Version 1.3



Europalaan 202  
7559 SC Hengelo (Ov)  
The Netherlands  
T+31(0)88 00 76 000

Contact us:  
[info@super-b.com](mailto:info@super-b.com)

Visit our website  
[www.super-b.com](http://www.super-b.com)

